

# *RK Series*

*By CSI Controls*



# *RK Series*

*By CSI Controls*

*Serious Products for Serious Contractors!*

220 Ohio Street · Ashland, OH 44805

Phone: 419-281-5767 Fax: 419-289-2535

csi@zoominternet.net · www.chandlersystemsinc.com

INDUSTRIAL CONTROL EQUIPMENT



## *User's Manual*

# RK Series

## Pressure Systems

The RK Series pressure systems are an innovative and economical solution for today's level control requirements. Using our proprietary pressure bell these ground breaking liquid level systems allow the user to change all settings and adjustments outside of confined space with no electrical level system components in wet areas, no cords to tangle or adjust, no mercury, no mechanical switches to fail, no probes to corrode, and no venting required.

The RK Series pressure systems combine the features of a pressure transducer, a pump controller with remote level settings and manual test / run switches, as well as battery backed up audible alarms. The duplex systems also include built in alternation, ten second lag pump delay, and separate lag pump on level setting. Because the pressure systems use the proprietary pressure bell to operate, they exceed intrinsically safe Class 1, Division 1 standards. The pressure bell transmits a pressure only signal to the controller so no voltage from the level sensing device enters the wet well. As the water level rises in the basin, pressure is created in the pressure bell sending an air only signal to the controller. Through the use of a control circuit board, conveniently located on the Sub-Door, this system allows the user to adjust all settings at precise levels in inches by simply turning a knob.

### Important:

We strongly suggest that you read and understand this entire manual before installation. Proper installation will ensure trouble free operation of the system.

### Standard Pressure Systems Include:





# RK Series

## Specifications

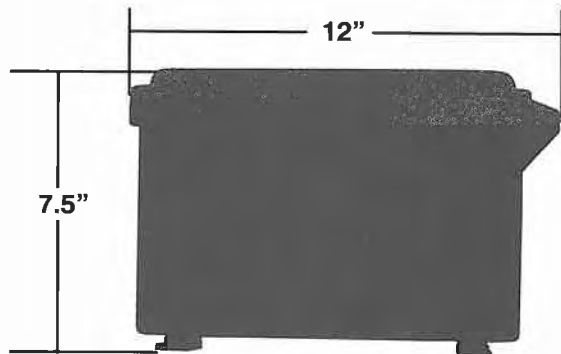
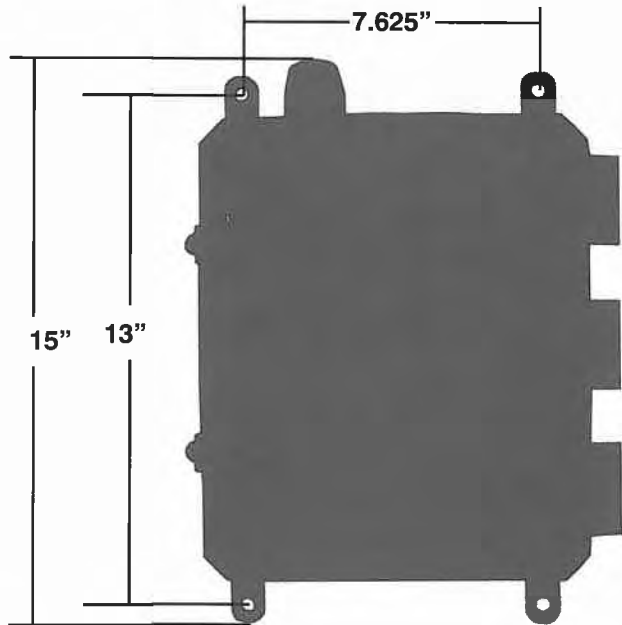
SPECIFICATIONS	Float Systems	Pressure Systems
	Available in Simplex & Duplex	Duplex Includes alternator & lag pump delay
Enclosure Dimensions	12.5" X 12" X 7.5"	
Overall Dimensions	14.5" X 12" X 7.5"	
Enclosure	Nema 4X with Molded Mounting Feet	
Alarm Piezo	95 db with "Touch to Silence" circuitry	
Float Status Lights	Displayed on Sub-Door	N/A
Battery Back-Up Alarm	N/A	9 VDC Audible Only
Flashing Red Alarm Beacon	Provides 360° Visual Display	
Weight	10.8 lbs.	
Contactor(s)	25 amp "DP" Heavy Duty Definite Purpose	
Includes:	20' Mechanical Floats (3 for simplex, 4 for Duplex)	Pressure Bell & 50ft of tubing
Aux. Alarm Contact Rating	5 amp 120 VAC	
Pressure Input	N/A	Min: 0 psi Max: 1.73 psi Max Overpressure: 10.8 psi
Controller Temp. Range	-40°F (-40°C) - +185°F (+85°C)	
Humidity	95% non-condensing	
Terminal Torque Ratings	Large - 35 inch lbs., Small - 12 inch lbs.	
Non-Conductive Injection Molded Sub-Door		
Blown Fuse Status Lights		
cULus 508 Listed		
Maximum 2 HP - (12 FLA) or 3 HP - (17 FLA) with HD option		
3 Year Limited Warranty		



 <b>WARNING</b> ELECTRICAL SHOCK HAZARD Disconnect power before installing or servicing this product. A qualified service person must install and service this product according to applicable electrical and plumbing codes.	 <b>WARNING</b> EXPLOSION OR FIRE HAZARD Do not use this product with flammable liquids. Do not install in hazardous locations as defined by National Electrical Code, ANSI/NFPA 70.
Failure to follow these precautions could result in serious injury or death. Replace product immediately if switch cable becomes damaged or severed. Keep these instructions with warranty after installation. This product must be installed in accordance with National Electric Code, ANSI/NFPA 70 so as to prevent moisture from entering or accumulating within boxes conduit bodies, fittings, float housing, or cable.	

### The Installer Will Also Need: (For Mounting Bracket Installation ONLY)



A 2" Male Adaptor



A length of 2" PVC pipe long enough to reach the bottom of the basin

### Step 1: Available Pressure Bell Mounting Options

Mounting Bracket                      Tether Kit



When using the mounting bracket to install the pressure bell, start by placing the bracket against the tank wall and mark the holes for the anchors. Drill the holes in the side of the tank and fasten the bracket to the tank. The bracket should be mounted near the top of the tank with access from the manhole cover.



When using the tether kit simply slide the 8 lb donut over the top to the pressure bell and thread the nipple into the pressure bell. Then suspend the bell by securing one end of the provided poly rope to the bolt on the top of the nipple and secure the other end of the rope near the top of the basin with access from the manhole cover. Top mount eyebolt is provided by the installer.

### Typical Simplex Pressure System Installation

**Note:** Care should be taken to insure that sewage gases are not allowed to enter the control panel with an approved sealing means!  
**(Damage caused by sewage gas is not covered by warranty).**

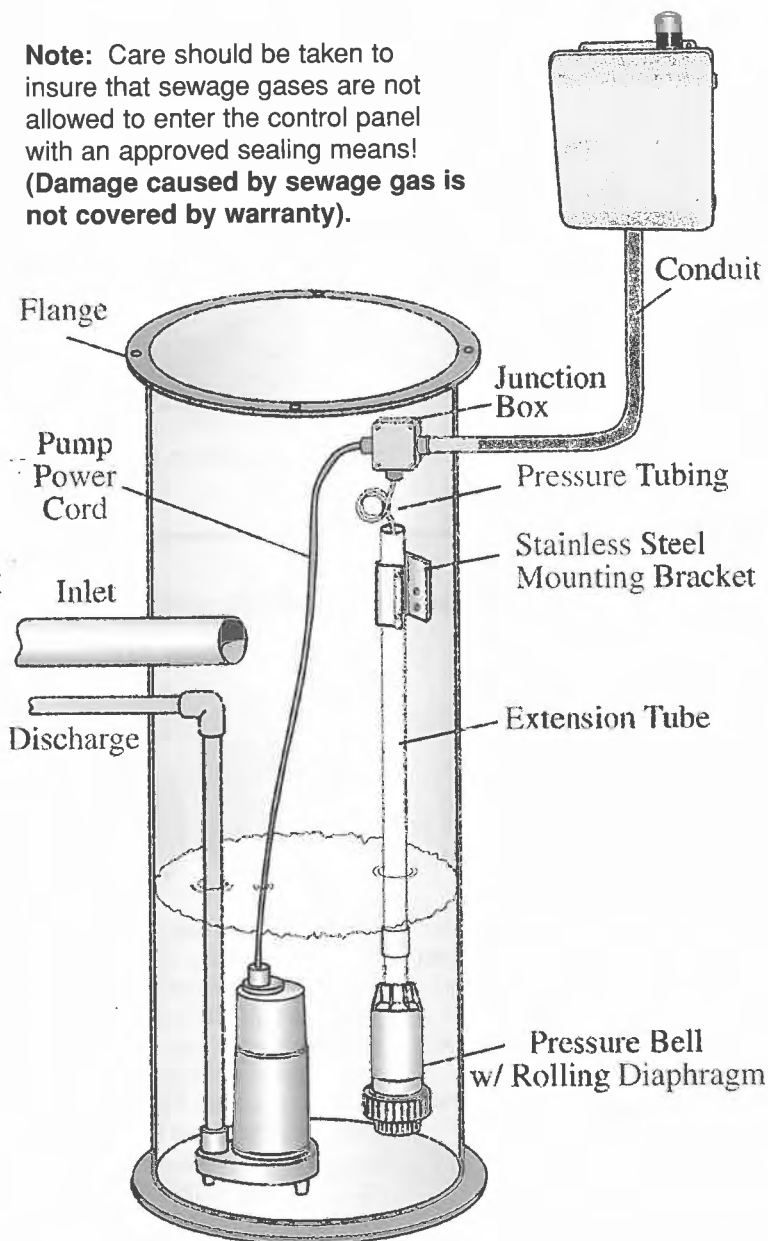

### Terminal Strip With All Available Options

L1	L2	N	1	2	3	4	N	5	6	7	8	9	10	11	12	13	14	15	16	17	18
----	----	---	---	---	---	---	---	---	---	---	---	---	----	----	----	----	----	----	----	----	----

Sample RKDF230ACB+ Terminal Strip

- L1, L2 & N 115/230 VAC Pump Power
- 1 115 VAC alarm power
- 2 115 VAC control power
- 3 & 4 Pump 1 Mtr.
- N For 115 Volt Pump Connection
- 5 & 6 Pump 2 Mtr.
- 7 & 8 Redundant Off
- 9 & 10 Off
- 11 & 12 Lead On
- 13 & 14 Lag On
- 15 & 16 Alarm
- 17 & 18 Aux. Alarm Contact

**Note:** Terminal strips differ between RK models and options. Your panel may be missing some of these terminal strip numbers. However, this example shows all possible field wiring connections.

### Determining Your RK Model Number

	<input type="checkbox"/> RK	<input type="checkbox"/>	<input type="checkbox"/>	<input type="checkbox"/>	<input type="checkbox"/>
Type	_____				
<input type="checkbox"/> ESF = E Series					
<input type="checkbox"/> SF = Simplex Float					
<input type="checkbox"/> DF = Duplex Float					
<input type="checkbox"/> SP = Simplex Pressure					
<input type="checkbox"/> DP = Duplex Pressure					
Voltage	_____				
<input type="checkbox"/> 115 = 115 Volt					
<input type="checkbox"/> 230 = 230 Volt (optional 115/230 Volt)					
Circuit Breaker Options	_____				
<input type="checkbox"/> = None					
<input type="checkbox"/> CB = Control and Pump Circuit Breaker(s)					
<input type="checkbox"/> ACB = Alarm, Control, and Pump Circuit Breaker(s)					
Other Options	_____				
<input type="checkbox"/> + = Includes Redundant Off & Aux. Contact Options					

## 8. Digital Display Center

With Future Expansion in Mind, Every RK Panel has a Removable Expansion Board Face Plate to Add a DDC if it is not factory installed. To install just remove the faceplate from above the control center on the sub-door and insert the DDC module from the back of the sub-door. Next, screw in the four corner screws and attach the ribbon from the DDC module to the control board.

### Back of DDC Module

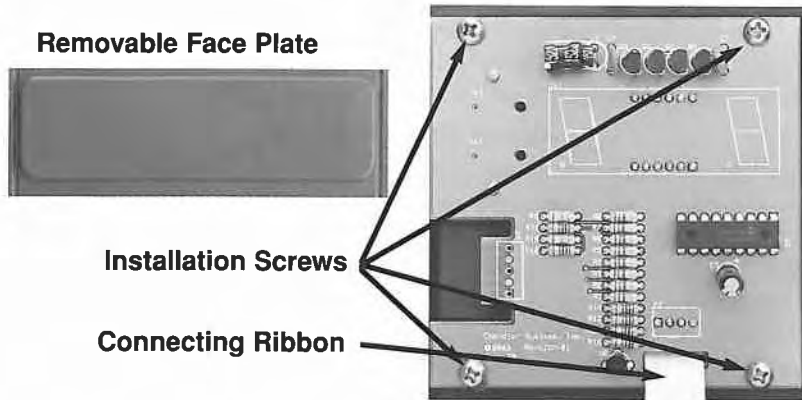

← Changes between functions.



← Changes between hrs. (eg. "1243") and minutes/seconds (eg. "42:12") on ETM function.

### DDC Read Outs

#### Pressure Only

DEPH (Depth in Inches)

#### All Panels

Et 1 (Elapsed Time Pump 1)

CC1 (Cycle Counter Pump 1)

#### Duplex Only

Et2 (Elapsed Time Pump 2)

CC2 (Cycle Counter Pump 2)

## Pressure System Installation Instructions Contd

### Step 2: Preparing the Pressure Bell

Once the mounting bracket is installed, you will need to cut the PVC pipe to the desired length. The length of the PVC pipe = Depth of Basin minus 14 inches (for the pressure bell) and minus an additional 6 to 12 inches (so the pressure bell is off the bottom of the basin). Once the length has been determined and the PVC has been cut attach the 2" male adaptor to one end of the pipe.



If for some reason your factory installed tube has been removed you will need to firmly attach the 1/4" poly tubing to the fitting at the top of the pressure bell. The tubing will push in 5/8" of an inch



With the tubing securely attached to the pressure bell, feed it through the PVC pipe from the side with the male adaptor already attached.



Finally, with the tubing securely fastened to the pressure bell and all the tubing fed through the pipe, thread the adaptor to the top of the pressure bell (Hand Tighten Only!).

### **\*IMPORTANT!**

The tube must be pushed into the fitting 5/8" or the unit will not work correctly!

### Step 3: Connect the Tubing to the Control Panel



### **\*IMPORTANT\***

The tube must be pushed into the fitting 5/8" or the unit will not work correctly!

With the control panel mounted in a convenient location to the basin, attach the other end of the 1/4" poly tubing to the control panel. To help insure that your system does not leak air it is best to not cut or splice the tubing. Leave enough extra tubing coiled up at the mounting bracket to allow the pressure bell to be removed for maintenance. If your installation requires cutting the tubing to exit a junction box make sure that you use the RKCF coupler fitting to insure a proper air seal!

### Step 4: Installing the Pressure Bell



With all the 1/4" tubing connected, you will need to remove the "Do Not Push or Pull the Diaphragm" sticker from the bottom of the pressure bell. Do not push the bottom of the pressure bell, but feel to make sure the rubber is tight against the cup. If it is not, refer to the section entitled "Seating the Rolling Diaphragm" (After Step 8) before continuing. Also,

make sure that all tubing is connected between the pressure bell and the control panel before submersing the bell in liquid. Note: Should the tubing become disconnected while the pressure bell is in the liquid you will need to pump the station down manually before reconnecting the pressure tubing. If there is an air leak or the diaphragm is not seated properly the system will not give an accurate measurement. The pressure bell can be mounted at any height off of the bottom of the basin that you desire. Remember that the lowest you will be able to measure will be at the top surface of the large union nut on the pressure bell.

### Step 5: Installing the Controller

1. Determine a mounting location for the panel.
2. Determine the location of the conduit(s) coming into the panel.
3. Drill holes in the panel for conduit entry.
4. Mount the panel using the provided mounting feet.
5. Bring the pressure tube and power wires into the panel through the conduit.
6. Wire the panel according to the schematic included in the panel.
7. Check installation by turning power on and manually running up the water level to test for proper installation.
8. Test the unit periodically to ensure proper operation.

### Step 6: Installing Battery Backup



The alarm circuitry in the pressure systems is 9-volt battery backed-up. The 9-volt power will sound the audible alarm and light the red alarm light on the front of the Sub-Door. It will not light the flashing red light on the top of the panel. To install the 9-volt battery open the Sub-Door and insert the battery into the clip on the circuit board.

### Features Common to Both Pressure & Float Systems

#### Alternation and Lag Delay on the Duplex Controllers

On the duplex controller the level settings are labeled LEAD and LAG because there is a built in alternator in the controller. The alternator cycles which pump is the lead pump after each PUMP RUN cycle. The non-adjustable delay causes the lag pump to wait ten seconds before turning on when the liquid level reaches the LAG PUMP ON setting. This is useful during a power outage when the liquid level may reach the lag pump setting. The lead pump will turn on when power is restored and the lag pump will turn on ten seconds later.

#### Hand Run Buttons

RK panels include push-to-run (HAND) pushbuttons for the motor starters output and a push-to-test (TEST) pushbutton for the alarm output accessible on the sub-door. The push-to-run (HAND) pushbuttons toggle their respective outputs off and on each time pushed under normal operation. However, to protect the pumps should the sump go below pump off level, the HAND pushbuttons revert to momentary contact and must be held down to maintain its respective output on. This is a safety feature that keeps the pumps from running dry.

#### Redundant Off Float Option

The redundant off float option reassures that the pump(s) will not run dry. If your panel has this option the terminal strip will include numbers 7 & 8. To use the redundant off option connect a normally open float switch to these terminals, otherwise install a jumper across terminals 7 & 8 if you do not wish to use this feature. When the float is in the open position the pumps will not be able to run except by using the hand run push buttons in momentary contact mode.

**Note: Section 3 Hand Run Buttons describes momentary contact mode.**

#### Audible Alarm Circuitry

RK panels come standard with an audible piezo alarm (95 db +/-) and the exclusive side mounted "Touch to Silence" pad (patents pending). With this feature the user is able to silence the audible by simply touching the decal on the side of the enclosure.

#### Blown Fuse Indicators

These lights are located above the fuses on the sub-door. If a fuse is blown the indicator above the blown fuse will light up and the power light on the sub-door control center for that circuit will be off. However, if the power light is off and the blown fuse light is not lit then that circuit is not getting any power.

## Float System Settings

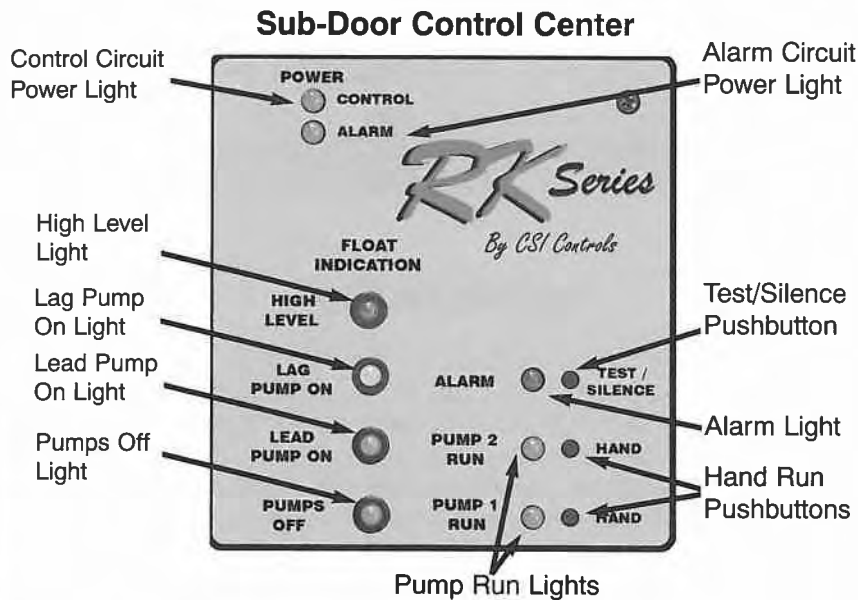

### Float Indication Status Lights

Float indication lights show the status of the floats in the basin. If a float is tipped closed the corresponding LED will be lit.

If the floats tip out of sequence it will cause the float indication lights to show an error. If a higher float comes on before the next lowest float the LED of the lower float will flash indicating a problem. For example if the "Lead Pump On" float hangs up and the water level comes down to the "Pumps Off" float level the "Pumps Off" float will tip down. The "Pumps Off" LED will then flash while the "Lead Pump On" LED remains on. However, the error indication will be automatically cleared next time the floats sequence in the proper order. Another example would occur when the "Pumps Off" float fails to close when it tips up. When the "Lead Pump On" float tips up the "Pumps Off" LED will then flash while the "Lead Pump On" LED remains on. Even though the error indication is the same there could be two causes for the error. The first cause being a hung up float, and the second cause being a float failure. These lights help to assist in troubleshooting float errors and station problems.

That's how easy it is to install the RK Float System from CSI. If you need any additional help please call the factory for technical assistance.

**1-800-363-5842**

## Pressure System Installation Instructions Contd

### Step 7: Adjusting the Settings



With all the tubing connected and the pressure bell installed in the basin you are now ready to adjust your level settings. To adjust the ON and OFF settings of the pump(s) and HIGH LEVEL alarm, turn the dials to the desired depth in inches on the faceplate. The inches on the dials are measured from the top of the union nut surface on the pressure bell upward. You can also turn the pumps on manually by pushing the hand run button

once to run and again to stop. (This button switches to momentary contact after low level setting is passed). When the pumps are running in run mode they will run until they reach the PUMP(S) OFF mark. If the pumps need to be run further, the hand buttons can be held in until the desired depth is reached. **Remember:** All settings are relative to the top of the large union nut on the pressure bell in the basin.

### Step 8: Fine Adjustments



With the pressure units the settings can be adjusted to a precise measurement. Using a digital volt meter, set on DC-Volt setting and placing the negative lead to the screw on the upper right corner of the label and the positive lead to the metal strip on the side of the dials, the volt meter will give a reading in inches by moving the decimal to the right one number. So a reading of 1.514 is the equivalent of 15.14 inches.

That's how easy it is to install the RK Pressure System from CSI. If you need any additional help please call the factory for technical assistance.

**1-800-363-5842**

## Seating the Rolling Diaphragm

The proper operation of the rolling diaphragm assembly is key for the proper operation of the pressure system. For the diaphragm to be seated, it must be snug around the push-cup inside of the pressure bell assembly. The diaphragm is seated and protected when sent from the factory. However, if the rolling diaphragm assembly has been pushed up by some method other than water pressure (someone manually pushing on it), it will be necessary to reseal the push cup in the diaphragm.

Properly Seated Diaphragm

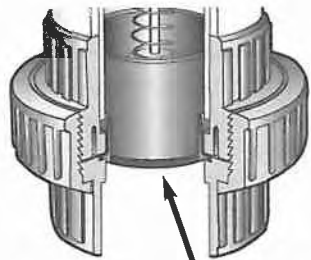

Rubber Diaphragm is tight against Push Cup

Improperly Seated Diaphragm

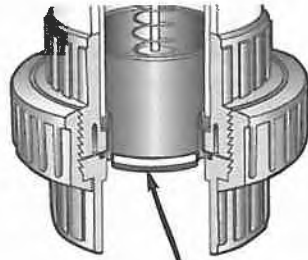

Air Gap between Rubber Diaphragm & Push Cup

A diaphragm that is not seated, or not seated properly must be reseated. Reseating the diaphragm can be accomplished by plunging the pressure bell into a liquid depth of about three feet. This must be done **without** the pressure tube connected to the controller. (To remove a pressure tube from the fitting push down on the small center ring on the top of the connector and pull the tube out). Once the diaphragm is reseated, the rubber will be snug around the internal push-cup and when lightly touching the diaphragm the push-cup can be felt immediately behind the diaphragm. Then make sure the pressure tube is reconnected to both the pressure bell and the controller **before** the bell is submerged in liquid.



### **\*IMPORTANT\***

The tube must be pushed into the fittings 5/8" or the unit will not work correctly!



Push here and pull tubing to remove tubing

## Float System Installation Instructions Contd

<b>WARNING</b> 	<b>ELECTRICAL SHOCK HAZARD</b> Disconnect power before installing or servicing this product. A qualified service person must install and service this product according to applicable electrical and plumbing codes.	<b>WARNING</b> 	<b>EXPLOSION OR FIRE HAZARD</b> Do not use this product with flammable liquids. Do not install in hazardous locations as defined by National Electrical Code, ANS/NFPA 70.
	Failure to follow these precautions could result in serious injury or death. Replace product immediately if switch cable becomes damaged or severed. Keep these instructions with warranty after installation. This product must be installed in accordance with National Electric Code, ANS/NFPA 70 so as to prevent moisture from entering or accumulating within boxes conduit bodies, fittings, float housing, or cable.		

## Installing the Floats

1. There are many different options to mounting floats. The installer can simply tie wrap or strap the floats to the pump discharge pipe at the appropriate levels using a heavy duty tie wrap or a clamp designed for that use. Floats can also be installed using a float mounting bracket w/cord snubbers and float weights as shown on the previous page. Finally the installer can purchase a pressure bell mounting bracket to suspend a length of 2" PVC pipe from. This allows the installer to mount the floats the same as they would to the pump discharge pipe.

- Warning:**
1. Do not install a float switch in direct line of incoming liquid.
  2. Make sure you leave at least 3.5 inches of tether length between the actual float and the clamping device to allow the float to tip properly.

## Installing the Controller

1. Determine a mounting location for the panel.
2. Determine the location of the conduit(s) coming in to the panel.
3. Drill holes in the panel for conduit entry.
4. Mount the panel using the provided mounting feet.
5. Bring the float and power wires into the panel through the conduit.
6. Wire the panel according to the schematic included in the panel.
7. Check installation by turning power on and manually tipping the floats or running up the water level to test for proper installation.
8. Test the unit periodically to ensure proper operation.

## Float System Installation Instructions

### Typical Simplex Float System Installation Using the Float Mounting Bracket

**Note:** Care should be taken to insure that sewage gases are not allowed to enter the control panel with an approved sealing means!  
**(Damage caused by sewage gas is not covered by warranty).**

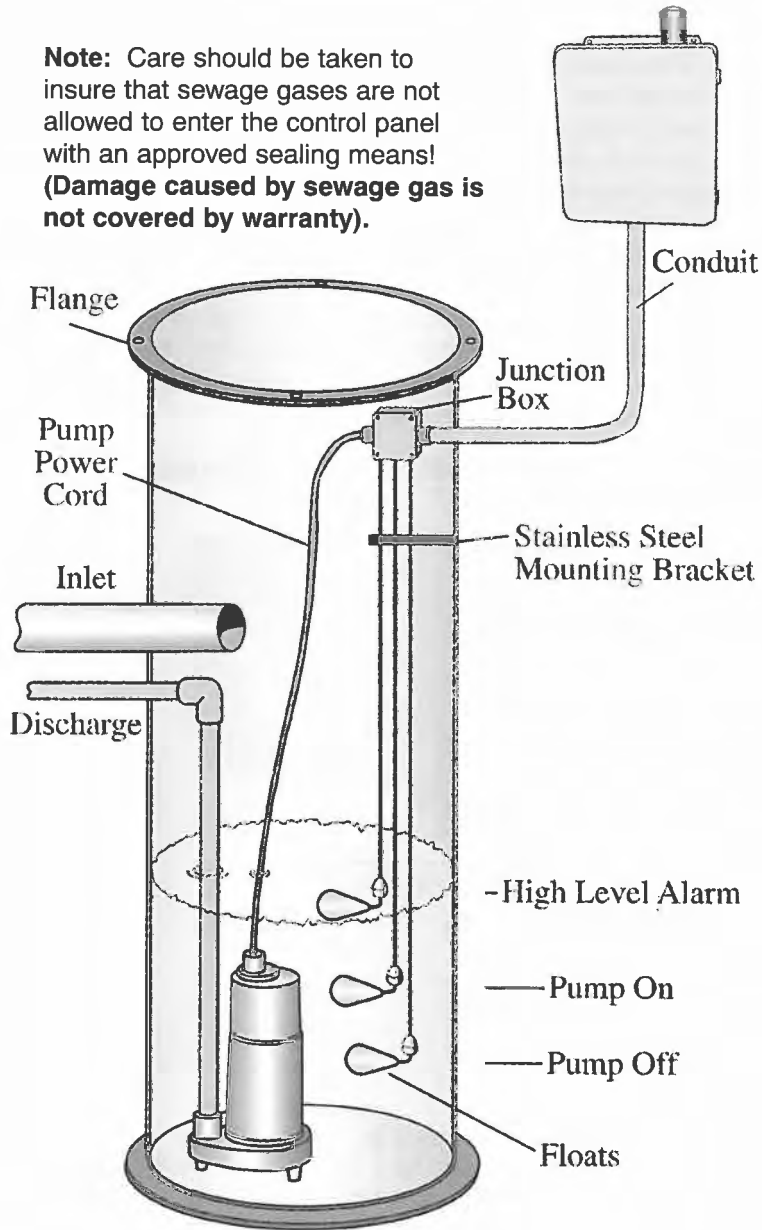

## Pressure System Adjustments

### Sub-Door Control Center

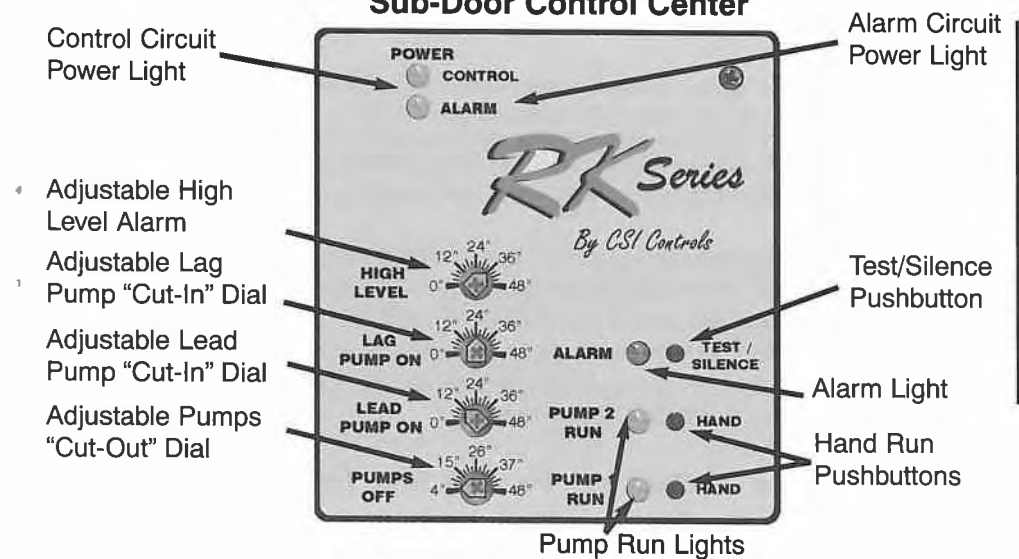

### The Level Set Points

The Pressure Systems are very simple to set and use. For each level setting you turn the dial to the level you want the controller to switch at. For example, using the duplex controller turn the PUMPS OFF dial to 4", the LEAD PUMP ON dial to 12", the LAG PUMP ON dial to 24", and the HIGH LEVEL dial to 36". As the level in the basin comes up the LEAD PUMP ON will turn on at 12", and LAG PUMP ON will turn on at 24" (with a 10 second delay), and as the liquid level in the basin is being pumped down the pumps will shut off at the PUMPS OFF level of 4". If for some reason a pump fails or the liquid level is coming into the basin quicker than the pumps can remove it, the liquid level in the basin will eventually reach the HIGH LEVEL setting of 36" and at this point the system will sound the audible and the alarm light will flash two flashes per second (fast). The HIGH LEVEL setting can be at any depth above your PUMP(S) OFF setting so that you can trigger an alarm below your LAG PUMP ON setting.

**Remember:** All settings are relative to the top of the large union nut on the pressure bell in the basin.

The Pressure Systems also contain an internal, non-adjustable low level / loss of pressure alarm. This alarm will occur if the liquid level falls below 3", or if the system air pressure is lost. The PUMP OFF setting can not be set below 4" so that the level in the basin will never be below the 3" level under normal operating conditions. If this occurs the alarm light will flash 1 flash per second (slow) and no audible will sound.

**Note: If the system losses pressure the most likely reasons are:**

- 1) Tubing is not fully inserted into quick connectors
- 2) Tubing in quick connectors is not cleanly and squarely cut on the end
- 3) The diaphragm on the pressure bell has somehow been punctured
- 4) The tubing has been cut somewhere and is leaking air

These level settings are designed to work similar to a float system. On the simplex system if the PUMP ON setting is set below the PUMP OFF setting the controller will turn the PUMP RUN light & a pump run contact on and off at the PUMP OFF level setting. Similarly the duplex controller will turn on and off at the PUMPS OFF setting if the LEAD PUMP ON setting is below the PUMPS OFF setting.

### Battery Backed Up Alarm & Aux. Contact

The battery provides power only to the alarm circuit when the normal 120VAC power fails. This would make an alarm condition available even when the power is off. The battery power is not used while the normal 120 VAC power is available.

The battery back-up maintains the alarm circuit so the alarm LED and alarm audible will work during a power outage. It does **NOT** power the alarm beacon.

To test the battery, use the following steps: First, remove the 120VAC power when the PUMP RUN light is not on. Next, press the TEST push-button. Look to see that the ALARM LED on the sub-door is on and the audible should alarm. If you have a multimeter handy you can also check for continuity across the aux. alarm contacts when the alarm button is pushed. If the LED does not come on, or the audible does not sound then the battery should be replaced.

**Note: Auxiliary Alarm contacts are optional and close during high level alarm then open when alarm condition goes away or when panel is silenced.**

To Maintain reliable battery backed-up service we suggest you replace the battery once a year.

**Note: If long or frequent power outages occur the battery may need to be replaced more often.**

The RK Series is an innovative approach to today's pump control system requirements with standard features unmatched by most competitors. Through the use of a standard sub-door and raised backpanel the RK Series offers a revolutionary design for housing common control panel features such as circuit breakers, start components, contactors and a terminal strip. While others ask you for more dollars to cover "options", the RK Series provides many of the most requested items as standard equipment. Some of these standard features include: lockable latches, a flashing red alarm light with an electronic horn, the innovative touch to silence pad, and a control circuit board all in a NEMA 4X enclosure. In addition to unsurpassed standard features RK offers an exclusive control circuit board. Conveniently located on the Sub-Door the float indication lights allow the user to see the status of each float and flashes should a float fail. Available in simplex and duplex single phase to three phase these innovative controllers are certain to revolutionize the industry.

### Standard Float Systems Include:



### Step 1: Available Float Mounting Options

#### 2" PVC Mounting Bracket



The same mounting bracket that is used to mount the pressure bell can be used for floats by mounting the bracket to suspend a length of PVC pipe and then tie wrapping the floats to the pipe at the appropriate levels.

#### Float Mounting Bracket



The installer may also choose to install the floats using one of our optional float mounting brackets w/cord snubbers and float weights.